

# Optical All-Loss Test Solution

## Application Note

Gunnar Stolze, Stefan Rathgeb, Markus Maile

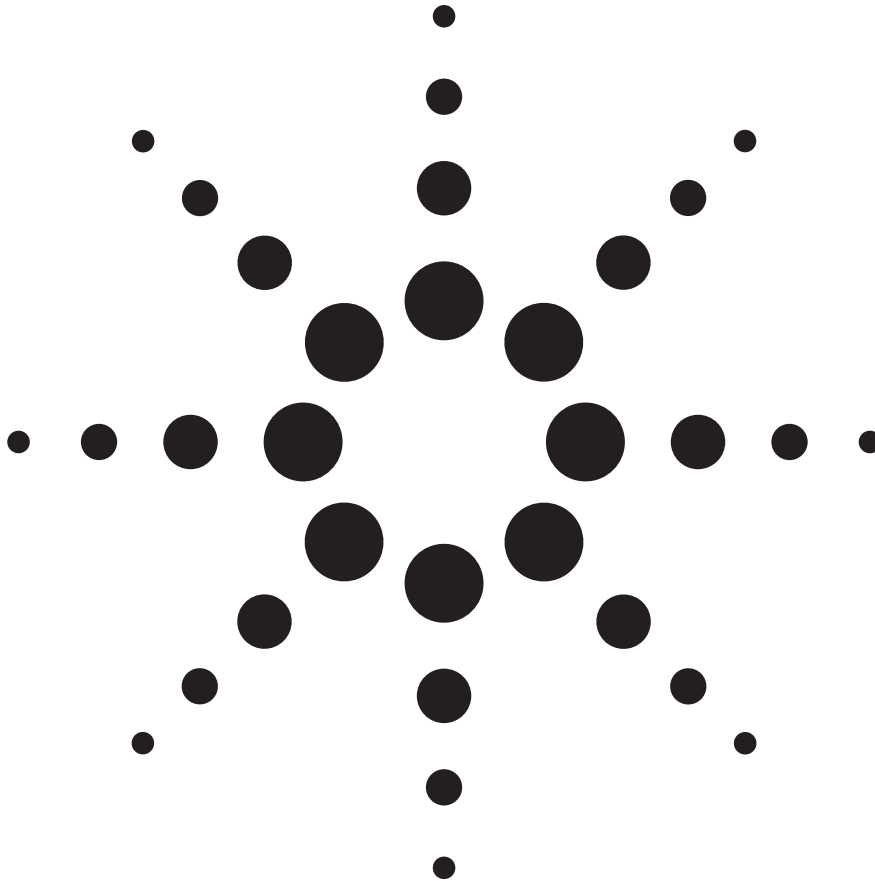

### **Abstract**

The Optical Loss Analyzer (OLA) test solution measures Insertion Loss, Polarization Dependent Loss and Return Loss.

The present application note introduces the OLA test solution, explains briefly the measurement parameters and discusses the measurement performance of such a solution.



**Agilent Technologies**

Introduction.....	2
Measurement Parameters, Principles .....	3
Insertion Loss.....	3
Return Loss.....	3
Polarization-Dependent Loss .....	4
The Optical Loss Analyzer – Different Test Solution.....	5
Generic Solution Design .....	5
Economic Solution with small footprint .....	6
High Accuracy Solution.....	6
Tunable OLA solution.....	7
Modules.....	7
Return Loss Module .....	7
Optical Heads.....	8
Polarization Controller.....	8
Sources.....	8
Measurement Performance.....	8
Power Stability .....	9
Degree of Polarization.....	11
PDL Uncertainty.....	11
PDL Repeatability .....	12
Reduction of PDL uncertainty with a depolarizer .....	13
Example Measurements .....	13
Return Loss.....	14
Summary .....	15

## Introduction

The Optical Loss Analyzer (OLA) test solution is a complete solution to characterize passive optical components for their loss characteristics. The solution measures insertion loss, return loss and polarization dependent loss (PDL). The solution is especially designed to measure the loss performance of broadband components, such as couplers, splitters etc., where the loss is very flat over wavelength.

The Optical Loss Analyzer test solution is based on a modular concept that flexibly meets different testing requirements, such as:

- high performance, low uncertainty measurements
- economic test solution with small footprint
- wavelength dependent measurements.

The optical all-loss analyzer solution represents a special solution for testing broadband components such as couplers or splitters.

The optical all-loss analyzer supports a variety of applications, such as:

- Insertion Loss Measurement of passive optical components, which is the power loss of lightwave signals passing through a device under test (DUT)
- PDL Measurement, which yields the variation of the insertion loss caused by the DUT's sensitivity to changes of polarization of the incident lightwave signal.
- Return Loss, which is a measure of the reflectance of a DUT and represents, what fraction of the incident lightwave signal is scattered back to the source.
- Coupler Test, which yields the Coupling Ratio (CR), Splitting Ratio (SR), Insertion Loss (IL), Excess Loss (EL), and directivity (DIR) of optical couplers
- Polarization dependent coupler test, which measures the polarization dependence of most coupler characteristics

The present application note first defines the three loss measurement parameters; Insertion Loss, PDL and Return Loss. The measurement performance of the various OLA test solution configurations, including considerations about measurement uncertainty are discussed in the next section. Finally, some performance tests are explained that can be used to verify the measurement uncertainty of an optical all-loss analyzer solution.

## Measurement Parameters, Principles

The following section defines the three loss parameters and describes the general measurement principles.

### Insertion Loss

Light that is absorbed, scattered or reflected by a component naturally affects the amount of light that is transmitted through the component. How much light is transmitted by a component is defined by its transmission factor, which is the ratio of the power of light that passed the component to the power of light that is incident on the component.

With respect to passive optical components, the insertion loss is the most important parameter to determine. The insertion loss of components deployed in optical networks determines the network's power budget calculation, thus indirectly influencing the number of required optical amplifiers and regenerators in the optical network. Because active signal amplification and regeneration induces high installation and operational costs on the network, it is highly desirable to reduce the number of such active components to a feasible amount. Thus, one of the basic requirements on passive components is to ensure low insertion loss. The insertion loss is the most important parameter of every component, thus it is verified for each component. Furthermore, from an insertion loss measurement, other parameters of the component may be deduced. For filters, these parameters typically specify the filter response properties, such as bandwidth. For couplers or splitters, the coupling (splitting) ratio can be found, or their excess loss.

The insertion loss in logarithmic terms is defined as the ratio of transmitted power to incident power:

$$InsertionLoss = -10 * \log\left(\frac{P_{transmitted}}{P_{incident}}\right) [dB]$$

**Equation 1 Insertion Loss definition in terms of optical power.**

To determine the insertion loss, two measurements are required, as shown in Figure 1.

- 1) The first measurement determines the power incident on the DUT,  $P_{incident}$ . For that matter, the optical source is connected directly to the power meter using a reference fiber.
- 2) The DUT is inserted into the test setup. The transmitted power  $P_{transmitted}$  through the DUT is recorded using the optical power meter

Both measurements must be performed under the same boundary conditions, i.e. output power level of the optical source, and wavelength.

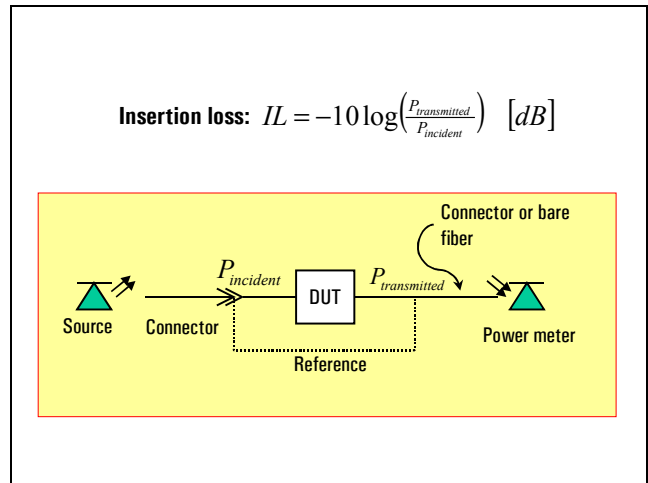

**Figure 1: Insertion Loss - Definition and measurement principle.**

In order to capture the insertion loss of the component only, components other than the DUT should be excluded from the optical setup or their insertion loss properties should be properly captured in the reference measurement.

Some of the main sources of uncertainties are connectors in the setup. Connectors, if dis- and reconnected, have typically a worst case repeatability of their insertion loss of tens of mdB.

For highest measurement accuracy, the device should be spliced into the setup. Then, the DUT measurement (step two – see above) is taken first. After measuring the transmitted power, the DUT is excluded from the signal path. The splice, which induces additional loss, should remain in the setup. The incident power (step one – see above) is measured. The insertion loss is calculated as above. The loss induced by the splice is captured in the reference measurement.

Other sources of uncertainty include unstable input power, stemming from short term fluctuations of the source or interference effects caused by multiple reflections. Also, changes in the state of polarization can lead to varying insertion loss values induced by the polarization dependent loss of the device.

### Return Loss

When light passes through an optical component, or fiber, most of the light travels in the forward direction, away from the emitting source. However, part of the light is scattered or reflected, eventually reaching back to the source. The reflected light is travelling in the backward direction, towards the source.

In many applications, such reflections are unwanted, because they can influence the emission characteristics of the source, apparent in output power fluctuations of the light source.

How much light is reflected by a component is measured by its return loss. The return loss is the ratio of the power of light that is reflected from the component to the power of light that is incident on the component.

$$ReturnLoss = -10 * \log\left(\frac{P_{reflected}}{P_{incident}}\right) [dB]$$

**Equation 2 : Return Loss Definition in terms of optical power.**

Return Loss measurements must therefore determine two parameters: the incident power and the reflected power, as shown in Figure 2.

Thus, two measurements are required to obtain the component's return loss:

- 1) The incident power  $P_{incident}$  level is measured. For that matter, the optical source is directly connected to the detector through a fiber.
- 2) The reflected power  $P_{reflected}$  is measured. Here, the reflected power is guided onto a detector using a splitter, that directs part of the reflected light to the power detector.

Both measurements must be performed under the same boundary conditions, i.e. output power of the optical source, and wavelength.

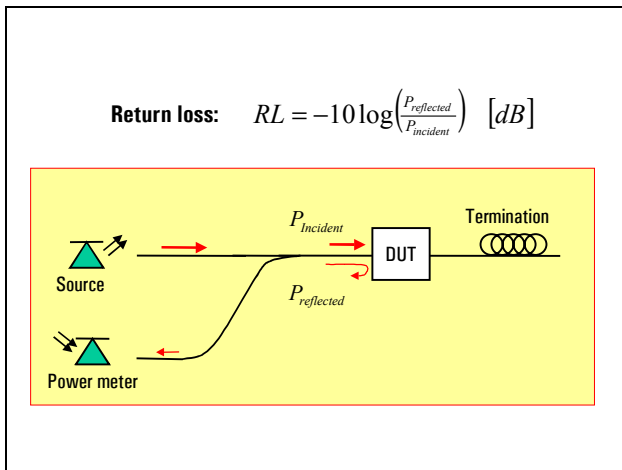

**Figure 2: Return Loss - Definition and measurement principle.**

In order to capture the return loss of the component only, other sources of reflections must be calibrated prior to the return loss measurement, or optical paths leading to additional reflections must be terminated. The latter is especially important for the output fiber of the DUT, which causes reflections at the open fiber end. The glass-air interface induces a return loss of approximately 14.8dB in the worst case, if the glass air interface is orthogonal to the direction of light propagation. Connector intersections can also cause reflections. A junction of two straight connectors produces a return loss of 40 to 45 dB. The magnitude of such reflections can

easily exceed reflections caused by the DUT itself, which would not be measurable anymore.

### Polarization-Dependent Loss

Polarization-dependent loss (PDL) is a measure of the peak-to-peak difference in transmission of an optical component or system with respect to all possible states of polarization. It is the ratio of the maximum and minimum transmission of an optical device with respect to all polarization states. The PDL is defined as:

$$PDL_{dB} = 10 * \log\left(\frac{P_{Max}}{P_{Min}}\right)$$

**Equation 3: Definition of polarization dependent loss.**

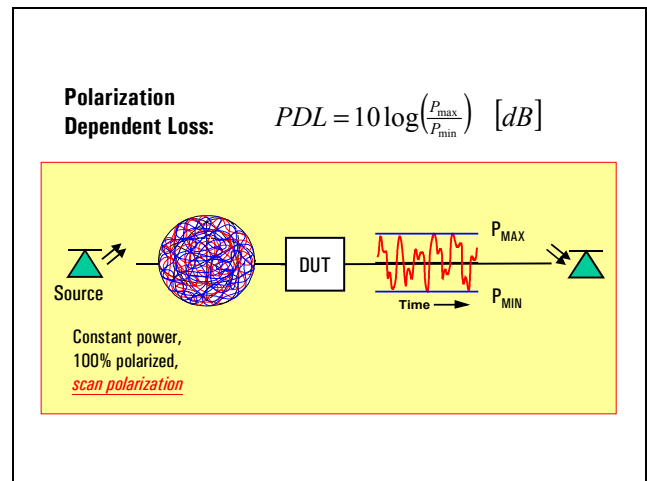

**Figure 3: Polarization Dependent Loss - Definition and measurement principle.**

The polarization scanning technique is the fundamental method for measuring PDL. The device under test (DUT) is exposed to all states of polarization and the transmission is measured with a power meter. The maximum and minimum transmission through the DUT can directly be measured. The polarization dependent loss can then be determined with Equation 3.

In contrast to an insertion or return loss measurement, a PDL measurement using polarization scanning technique does not require a reference measurement, as it is only a relative measurement, where the absolute power levels are not important. The measurement principle just relies on the determination of the difference of maximum and minimum transmitted power, regardless of the incident power level.

The polarization-scanning technique is fairly easy to implement. A typical measurement setup uses a source, a polarization controller

that generates different states of polarization deterministically or pseudo-randomly, and a power meter, as shown in Figure 3.

Exposing the DUT to all states of polarization is fairly impossible. In practice, a number of polarization states is generated at a scan rate that is suitable for the power meter averaging time. The longer a polarization scan takes, where the transmission through the DUT is obtained at more polarization states, the smaller the uncertainty of the PDL measurement. However, at some point an increase of the measurement time does not yield a significant improvement of the measurement accuracy. A balance between measurement accuracy and measurement time is important. This will be treated in greater detail in a later section.

A high level of power stability is mandatory for obtaining accurate PDL measurement results. The PDL uncertainty is basically influenced by the following factors: The polarization sensitive response of the detector, the source power stability and degree of polarization, and the transmission variation over polarization of the polarization controller.

A detector with low polarization dependent responsivity must be used in order to keep its influence on the measurement small enough. A source with a high degree of polarization is important for PDL measurements. The polarization controller changes the state of polarization of the polarized fraction of the light, but does not affect the unpolarized part. Therefore, any unpolarized fraction of the light is transmitted independent of the DUT's PDL. The optical power meter cannot detect the PDL if the DUT is exposed to unpolarized light.

Finally, the polarization controller exhibits some polarization dependent loss variation over polarization. In case of pseudo-random generation of polarization states, the accuracy of the measurement relies on low loss variation of the polarization controller across all states of polarization.

The PDL uncertainty is therefore mainly influenced by the source power stability, the PDL of the receiver and the insertion loss variation of the polarization controller.

Assuming a source power stability of 0.006dB, an insertion loss variation of 0.004dB and 0.004dB PDL of the detector, the total uncertainty is then given with 0.008dB.

The major source of systematic error comes from the fact that the scanning time, or measurement time, is finite. Therefore, the DUT is only exposed to a finite number of polarization states. The scanning time that is required to obtain a certain systematic error is related to the rate of change in polarization that the polarization controller can perform. The minimum angular step in scanning the Poincare sphere, which is correlated to the minimum achievable systematic error  $\mathcal{E}_{min}$ , is given by the product of the polarization controllers angular velocity of rotation  $\nu$  and the averaging time  $\Delta t$  of the power meter:

$$\mathcal{E}_{min} = \frac{(\nu \Delta t)^2}{4\pi}$$

The total measurement time, which depends on the power meter averaging time  $\Delta t$  and the desired systematic error  $\mathcal{E}$ , is given by:

$$T_{total} = \frac{\pi \Delta t}{2\mathcal{E}}$$

As an example, assume that the desired systematic error is 0.1%, with a power meter averaging time of 1ms. Then, the total scanning time is  $T_{total} = 1.5s$ .

## The Optical Loss Analyzer – Different Test Solution

As described above, the OLA test solution is able to measure insertion loss, PDL and return loss. The sources of uncertainties for each of the measurement parameters as discussed above must be taken into consideration when designing such a test solution. This section provides an overview of the generic solution design and how possible impairments on the measurement uncertainty can be avoided.

Furthermore, the choice of sources determines which testing requirement is addressed, namely economic solutions with small footprint, high accuracy test solutions, and loss measurements over wavelength are briefly discussed. The generic solution design remains the same, regardless of the choice of the source.

### Generic Solution Design

The design of the test solution is impacted by the following requirements:

- the test solution can determine all three loss parameters
- the DUT is only connected once to the test solution in order to measure all loss parameters
- the accuracy of the OLA test solution should be equal or similar to the accuracy of single solutions for each parameter

A generic test solution fulfilling all the above requirements is shown in.

It consists of the following modules:

- a mainframe
- Return Loss Module 8161xA with or without integrated FP laser sources
- 81624B optical heads, including an interface module to connect the optical heads to the mainframe
- 11896A polarization controller with angled input and output connectors

- an external source ( not required for economic solution )

The dependencies in this solution can be related to the main sources of uncertainties as described above.

Accurate Return Loss measurements require a) a good calibration of the return loss module, and b) that the return loss contributions from the test solution components are neglectable or smaller than the return loss of the DUT. As mentioned above, straight connector interfaces may result in return losses to the order of 40dB. In contrast, the return loss of angled connector interfaces is much higher, on the order of 55dB to 60dB and higher, depending on the quality of the connectors and fiber end faces.

The contribution of the polarization controller itself is small enough not to impair the return loss measurements because of its fiber-based design.

Measuring PDL posts some other requirements on the test solution. For example, a coupler that is included in such a measurement solution to enable return loss measurements usually has polarization dependent transmission characteristics, which would be captured in a PDL measurement. Due to the nature of PDL, the polarization dependence of the test solution components and the DUT cannot be separated.

On the other hand, a polarization scrambler, used to change the state of polarization of light for PDL measurements, itself induces reflections. To avoid an impairment on the return loss accuracy, angled connector interfaces must be used to reduce the return losses induced by the instruments or connector interfaces.

Another effect that might occur in the measurement setup are multiple reflections from straight connector interfaces, which induce interference effects along the signal path. Such interferences appear as power fluctuations when measuring the optical power.

Therefore, a careful design and calibration of such an all-loss solution is important to obtain highly accurate results for all three loss parameters. Taking the considerations above into account, all instruments are equipped with angled connectors. The polarization controller is placed before the DUT, so that by scanning the polarization controller, only the loss variation of the DUT is captured. The only sources of uncertainties are the loss variation of the polarization controller itself and the polarization dependent responsivity of the detector, whose impact can be reduced by choosing appropriate instruments.

In the following, the three different types of OLA test solutions are briefly discussed.

### Economic Solution with small footprint

One of the advantages of the Return Loss Modules 81611/2/3/4A is that each module contains a single or dual wavelength Fabry-Perot laser source. The integrated FP laser sources can be used to measure all three loss parameters: Insertion Loss, PDL and Return

Loss. The main advantage of the integrated sources is that a separate source module is avoided. Consequently, only a two slot mainframe such as the 8163 is required to host a return loss module with integrated sources and the interface module to connect with the optical heads, as shown in Figure 4.

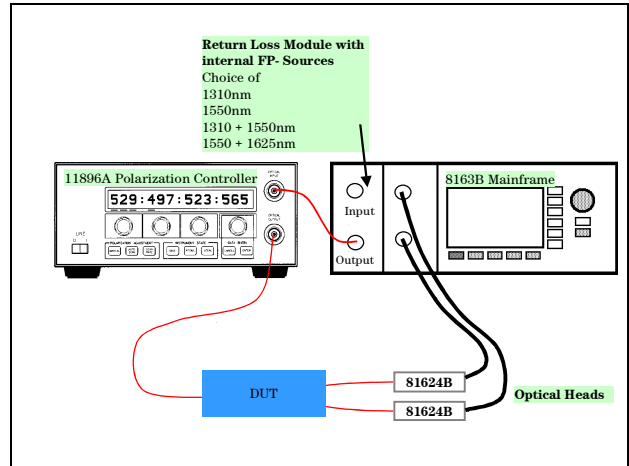

Figure 4: Components of the economic Optical Loss Analyzer Solution: Mainframe 8163B with Return Loss Module and Dual Channel Interface Module, Optical Heads and Polarization Controller.

### High Accuracy Solution

High accuracy of loss measurements is, among other factors, determined by the source power stability. As the solution is designed in such a manner that either the contributions of the individual instruments to the accuracy is minimized or can be calibrated, the only remaining option to maximize the accuracy is to employ a source with excellent power stability. For that matter, an external Fabry-Perot laser source is the best choice, because these source modules are designed for highest stability (i.e. lowest power fluctuations, short and long term). However, an additional module requires an extra slot space. The 8164 mainframe provides four slots, sufficient to host all required modules, as shown in Figure 5.

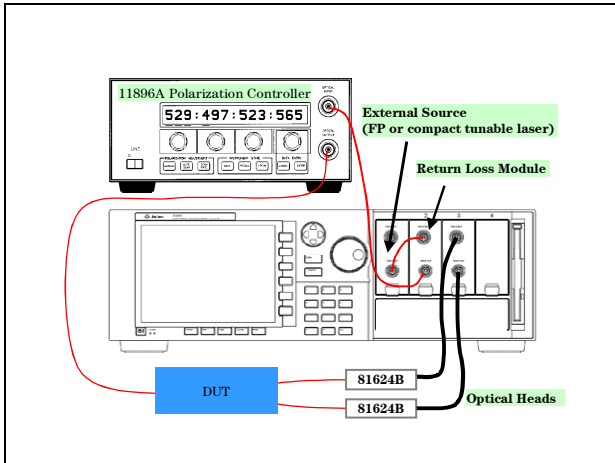

Figure 5: Components of the High-Performance / Tunable Optical Loss Analyzer solution.

### Tunable OLA solution

Sometimes, the loss is required at a range of wavelengths. For that reason, a compact tunable laser source (C-TLS) 81649A , 81689B should serve as the source. All modules are hosted in a 8164 mainframe. The design of the solution is as shown in Figure 5, with the exception that a tunable rather than an external Farby-Perot laser source is used for the measurements.

To summarize this, the required modules for the different types of solutions are again listed in the following table:

	Source	Return Loss	Power Meter	Mainframe
Economic	sources of Return Loss Module	81611/2/3/4 A	81624B	8163
High Perform.	Ext. laser sources 8165xA	81610A, optional others	81624B	8164
Tunable	81649A (L-Band) 81689B (C-Band)	81610A, optional others	81624B	8164

Table 1: Required Modules for different OLA solutions. The polarization controller 11896A applies to all three.

## Modules

In the following sections, the key features of the modules important to the operation of the optical loss analyzer are described<sup>1</sup>.

### Return Loss Module

The Return Loss Module is the central part within the optical loss analyzer solution. As its name already reveals, the module is designed for return loss measurements.

In the optical loss analyzer solution, the module also serves as the source, as the Return Loss Modules 81611/2/3/4A provide single or dual wavelength Fabry-Perot sources, emitting at the following wavelengths:

- 1310nm
- 1550nm
- 1310nm and 1550nm
- 1550nm and 1625nm

The Return Loss Module 81610A does not contain an internal source and is used in conjunction with an external source, such as an external Fabry-Perot or tunable lasers.

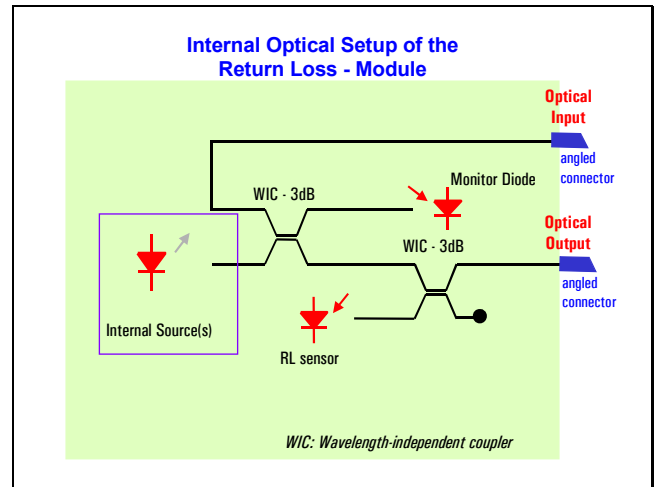

Figure 6: Optical Setup in the Return Loss Module.

Each return loss module provides an optical input to optionally connect an external source to the optical analyzer solution.

The Return loss module contains a power sensor, a monitor diode and two couplers. The power sensor measures the power reflected from a component, which is directed to the power sensor by a coupler. The monitor diode captures the input power, either of the internal or external source(s). Reading the source power ensures that possible fluctuations are captured and referenced to the measured reflected power, where any source power fluctuation is

<sup>1</sup> For more details on the modules, and for safety information for laser source operation, please refer to the manual of each module.

also apparent. As an example, Figure 7 shows the measured, nominal fixed return loss at different input powers. The measured return loss is not influenced by the variation in optical input power.

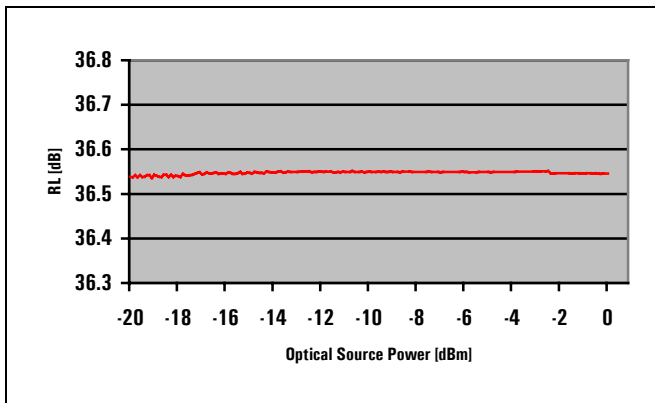

**Figure 7: Monitoring the input power minimizes the impact of power fluctuations on return loss measurements.**

## Optical Heads

Optical heads are used to measure the optical power of light emitted by connected optical fibers. The optical head 81624B uses a 5mm InGaAs photodiode as the optical detector, which has excellent optical performance in terms of spectral ripple and polarization dependent sensitivity.

The optical heads are connected to the mainframe through an interface module. This way, more handling flexibility is provided, as the optical heads are detached from the mainframe. The optical heads can be placed on an optical workbench, whereas the rest of the test solution may be placed in a rack or shelf.

## Polarization Controller

The Agilent 11896A adjusts polarization and not power, and is an important part of the all-loss optical test solution. Its optical fiber loop design provides all states of polarization with extremely small optical insertion-loss variations ( $\pm 0.002$  dB) over a wide spectral range: 1250 to 1600 nm. This performance combination maximizes measurement accuracy, which is especially important for low-PDL devices.

The polarization controller adjusts the polarization of an optical signal as it passes through the internal four-fiber-loop assembly. Each loop's dimensions are optimized to approach a quarter-wave retarder response over the controller's specified wavelength range. The movement of the fiber loops causes a variation of the birefringence in the fiber, which produces in the end a varying polarization. Complete and continuous polarization adjustability is achieved by independently rotating each loop over a  $180^\circ$  angular range. The different rotation speeds of the fiber loops generate

polarization states in a pseudo-random manner. The polarization controller provides 8 different scan rates, where the fastest scan is denoted by rate 8.

## Sources

As mentioned above, the Return Loss modules, except the 81610A, contain internal laser sources, either single or dual wavelength sources.

External sources can be connected to each Return Loss module. This is especially helpful for the High-Accuracy or Tunable OLA solutions. However, the internal and external sources can be combined to achieve optimum wavelength coverage:

- Add another 1310nm Fabry-Perot laser to the solution. Together with the internal 1550/1625nm dual wavelength source, a wide wavelength range can be covered with 3 wavelengths, which is typically sufficient for broadband parameters, such as couplers.
- Add a compact tunable laser to the solution. The compact tunable lasers, available for C and L-Band, cover a 50nm range each, with smallest wavelength resolution of 10pm. With a compact tunable laser, all measurements can be performed at various wavelengths within the specified bands.

The choice of the optical source impacts the achievable measurement accuracy, mainly determined by the source's output power stability and repeatability, as well as its linewidth. The laser linewidth and hence the laser coherence length determines the strength of interference effects caused by multiple reflections within the setup. The influence of such effects on the measurement accuracy will be discussed in a later paragraph.

## Measurement Performance

In this section, estimates for the measurement performance of the OLA test solution are given. The performance considerations include discussions about power stability, where it has been distinguished between the source power stability, and the power stability of the light signal incident on the DUT.

The PDL measurement uncertainty and repeatability are investigated.

All investigations consider different sources, such as the Fabry-Perot laser sources integrated into a Return Loss Module<sup>2</sup>, external Fabry-Perot laser sources<sup>3</sup>, and compact tunable laser sources<sup>4</sup>.

<sup>2</sup> Return Loss Modules with Fabry-Perot Lasers: 81611/2/3/4A

<sup>3</sup> External Fabry-Perot Lasers: 8165xA

<sup>4</sup> Compact Tunable Laser source: 81689A



## Power Stability

### Why Power Stability is important

In a PDL measurement using the Scrambling method, the maximum variation in power over polarization states is measured, which is taken as the PDL value. The actual measurement principle relies on capturing the minimum and maximum optical power over time, while the polarization state of the incident light is changed. However, measurement and signal conditioning are somewhat de-coupled. It cannot be determined from the measured power values, whether a change in power was caused by the DUT because of polarization dependent transmission properties, or because of a fluctuating output power of the source.

Therefore, a high level of power stability is mandatory to obtain accurate measurement results. The PDL uncertainty is basically influenced by two factors: The polarization sensitive response of a detector, and the source power. As the polarization dependence of a detector is difficult to reduce, the power stability remains the main problem worth addressing.

### Warm-up time

Before taking any measurements, the measurement equipment must warm up to reach a steady state.

Warming up the equipment is essential to keep the influence of the setup on the measurement results as low as possible. Only if the source output power has stabilized, accurate measurement results can be obtained.

During the warm-up period, the source output power can change due to varying environmental conditions, such as temperature. As an example, the behavior of the output power of a Fabry-Perot laser built-in to a return loss module is shown. The graph shows that during the first hour of operation, the output power can undergo large variations and in the end converges to a steady state.

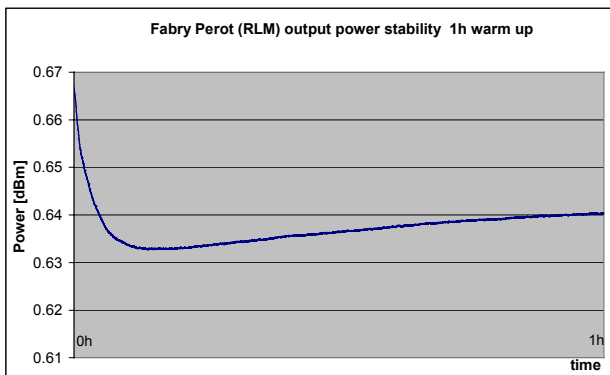

Figure 8: Output power of Fabry Perot Laser Source in Return Loss Module over 1hour during warm up time.

## Long and Short Term Stability

The power stability is a measure of the source power fluctuations, expressed in terms of the difference of maximum to minimum output power in logarithmic scale, measured during a specified period of time.

Power Stability is actually an inexact term, because it is determined by two effects that differ in time scale.

For short term observations, the thermal noise of the output power is measured. This is defined as the short term stability. Such a measurement does not capture the effect of source power drifts, where the power level can change dramatically. Such long-term drifts typically occur over a longer time scale, therefore, the result is called long term stability. If the power does not experience any drift movements, the long term stability measures the thermal noise of the source. However, if the power experiences a large drift, the thermal noise of the source cannot be captured with long-term stability, although actual measurements are performed over short time scales.

As an example, Figure 9 shows the measured stability of various sources. For each source, the long and short term stability are depicted.

The graph shows, that the long term stability of the Fabry-Perot Laser built-in to the Return Loss Module is much worse than the short term stability. This leads to the assumption that both sources experience power drifts over time. In contrast, the compact tunable laser shows almost the same level of power stability for long and short term observation, which is due to thermal noise and low power drift.

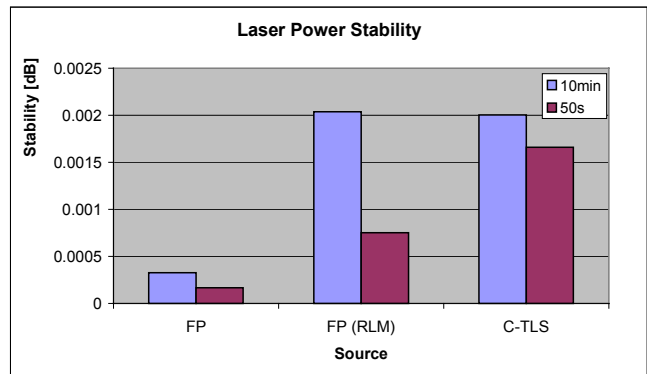

Figure 9: Long and Short Term Power Stability of various Sources.

Measuring the source power stability must therefore be related to the actual measurement time that is needed to characterize a DUT.

## Influences of the Setup on Power Stability

So far, the investigations have concentrated on the stability of the source output power itself. For that matter, the source had been directly connected to an optical receiver.

The question remains as to whether there are other possible sources for instabilities in a test setup as proposed in Figure 4 or Figure 5. In particular, it should be examined what influences additional devices in a test solution exhibit on the stability of the optical power that is incident on the DUT.

For that matter, devices such as a polarization controller or various types of connections are included step by step between the source and power meter.

The setup has been modified as follows:

- an angled to angled connection added
- a straight / straight connection added
- a polarization controller with straight connectors added

The results of the stability measurements<sup>5</sup> are shown in Figure 10 in comparison to the power stability of the source itself, as described in the previous section. Clearly, the introduction of a straight to straight connection, generated by linking two patch cords with straight connectors together, significantly impacts the power stability if a compact tunable laser serves as the source. In contrast, using a Fabry-Perot laser, regardless of whether it as a stand-alone module or built-in to the Return Loss Meter, the straight to straight connection does not significantly influence the stability.

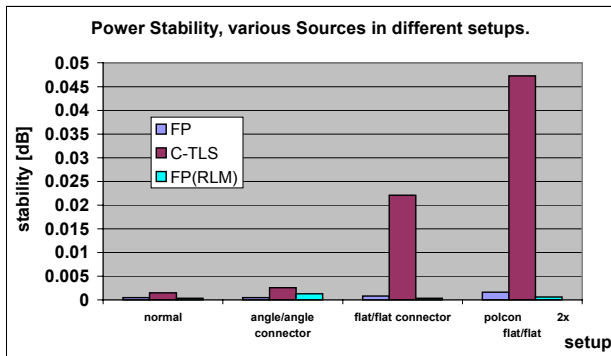

Figure 10: Influence of various setups on the power stability.

What is the reason for this dramatic change in stability? Comparing the source properties, it is striking that the test setups experiencing greatest impact from the straight connection where those that employed narrow linewidth sources. A tunable laser has a linewidth of a couple of hundred kHz. In contrast, the Fabry-Perot lasers have an rms<sup>6</sup> spectral bandwidth of a few nm, and the changes are much less dramatic.

This allows us to assume that these dramatic changes could be induced by interference effects. Figure 11 and Figure 12 represent

the actual stability measurement results, with tunable laser and Fabry-Perot laser as the source, respectively. Clearly, the power stability of the setup employing a tunable laser source shows periodic oscillations, a reasonable sign of the presence of interference. The narrower linewidth of the tunable laser source also explains, why the power stability is worse for the tunable laser compared to the DFB laser.

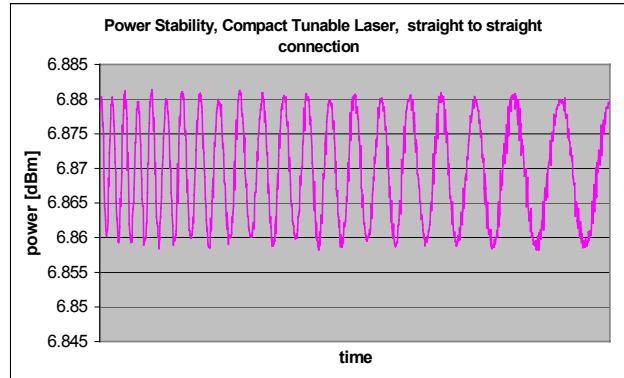

Figure 11: Power Stability measured with a straight to straight connection in the setup. The source is a tunable laser.

An even stronger deterioration of the power stability occurs when a polarization controller with straight input and output connectors is introduced into the setup. This is easy to understand when you consider that a polarization controller has two connections. If both connections are straight to straight, then the effect discussed above amplifies, as is clearly visible in Figure 10.

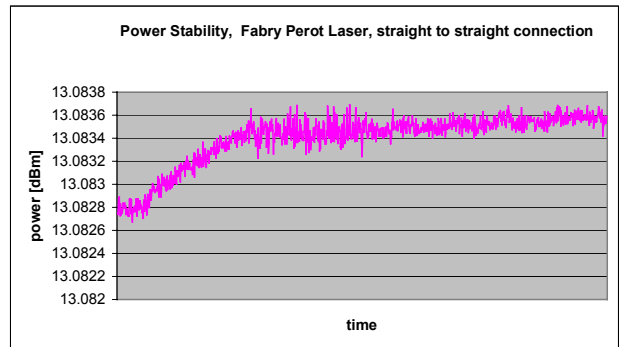

Figure 12: Power Stability measured with straight to straight connection in the setup. The source is a Fabry Perot Laser.

The conclusion from these investigations is not to avoid using of narrow linewidth sources such as tunable lasers, but to avoid the use of straight to straight connections within the setup. In particular, the polarization scrambler requires angled connectors to reduce the impact on the overall power stability of the light signal incident on the DUT.

<sup>5</sup> The power stability was captured over 60sec, with an averaging time of 10ms.

<sup>6</sup> rms = root mean square

A further solution to interference problems is to use source modulation capabilities. The modulation of the source induces a linewidth broadening, which in turn reduces the impact of interference effects caused by multiple reflections within the setup. However, the source modulation is not suitable for very short averaging times of less than 1ms, because then the actual modulation of the source is captured in a power stability measurement.

### Degree of Polarization

To perform PDL measurements, it is mandatory to have a source that emits almost 100% polarized light. Obviously, determining the polarization dependence of a DUT requires changing the state of polarization of the incident light, ideally to all states of polarization. However, a polarization transformation requires a defined polarization state as input. Furthermore, the polarization dependence of a DUT can only be determined, if the incident polarization state is stable and unique, i.e. a single polarization state.

For that matter, the degree of polarization for different sources has been verified. The DOP of the sources has been determined in two ways: using an Agilent Polarization Analyzer 8509B and the Agilent 8169A polarization controller, used as a polarimeter. The measurements show, that all sources emit nearly 100% polarized light, as depicted in Figure 13. Thus, the sources are suitable for PDL measurements.

For comparison, the DOP of an ASE broadband source<sup>7</sup> has been measured using the same methods. An ASE source typically emits highly unpolarized light, which was detected correctly by the two methods. An ASE source is therefore not suitable for PDL measurements.

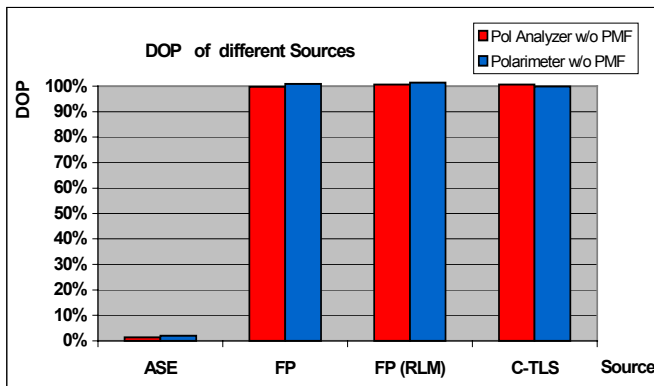

Figure 13: Degree of Polarization (DOP) for different sources.

### PDL Uncertainty

The PDL uncertainty is a measure of all random and systematic uncertainties from a source, the polarization controller and the optical power meter. In particular, power fluctuations from the source, the impact of non-ideal measurement setups, insertion loss variations of the polarization controller across all states of polarization, and the polarization dependent responsivity of the detector are some of the main influencing factors.

The PDL uncertainty has been determined empirically by finding the maximum of a series of obtained PDL values. Basically, the PDL uncertainty is determined using a simple patchcord between polarization controller and optical receiver. In between measurements, the patchcord has been moved to change its polarization transformation properties. In this way, the detector influences on the uncertainty can be captured. The measurements have been performed for different sources.

Figure 14 shows the PDL uncertainty results for different sources. The reason for the differences in uncertainties is related to the stability of the source itself, but also to possible interference effects in the optical setup as discussed in the previous section.

From the results, using an external Fabry-Perot laser leads to the smallest PDL uncertainty, which is less than 0.005dB.

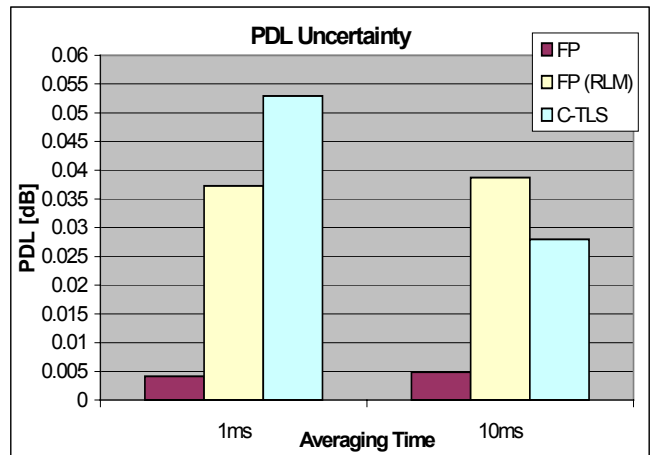
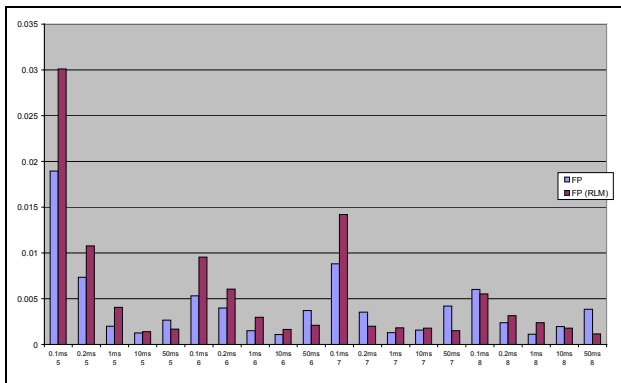

Figure 14: PDL uncertainty for different sources.

<sup>7</sup> ASE= Amplified Spontaneous Emission

## PDL Repeatability

The PDL repeatability is a measure of the uncertainty in reproducing PDL measurement results with unchanged conditions. That means, that for a series of repeated PDL measurements, fibers are not moved or disconnected from the equipment. The repeatability is half the span between maximum and minimum value for all PDL values. The repeatability of a PDL measurement is always related to the rate of change in polarization and the averaging time of the optical power meter, as shown in Figure 15.

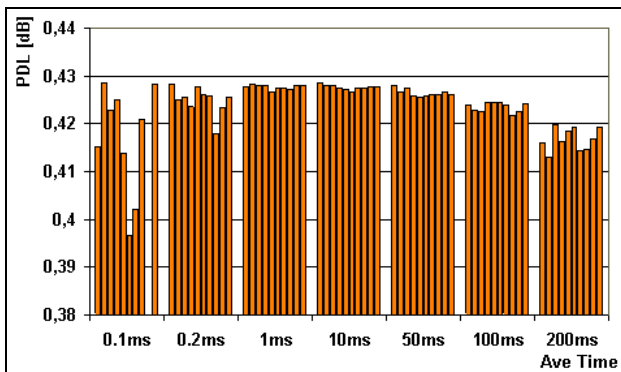

**Figure 15: Repeatability of PDL measurement results, over different polarization scan rates and averaging times.**

In the graph, the repeatability is shown versus different scan rates and averaging times. It can be seen from the graph, that for each scan rate, there is an averaging time that yields the best repeatability of PDL values. For a scan rate of 5 or 6, a suitable averaging time is 10ms, and for a scan rate of 7 or 8, the averaging time can be 1ms or less.

As an example, consider the repeatability of the obtained PDL results when scanning at rate 6, for different averaging times, as shown in Figure 16.

The nominal PDL value of the DUT was  $0.45\text{dB} \pm 0.02\text{dB}$ .



**Figure 16: Repeatability of PDL measurements at scan rate 6 for different averaging times.**

It is obvious, that the worst repeatability occurs at short averaging times of the power meter, i.e. at  $100\mu\text{s}$  and  $200\mu\text{s}$ . The reason is that short averaging times also mean short measurement times, given that the number of data points is constant for all measurement times. The uncertainty, that the PDL has been fully determined in the given measurement time, i.e. that the absolute minimum and maximum transmission have been measured during that time, is rather high, because the probability that the corresponding polarization states have been generated by the polarization controller becomes smaller with shorter measurement times.

This is of course related to the scan rate of the polarization controller, which is the rate of change in polarization. The faster the scan rate, the more polarization states are generated, so the probability that the polarization states exhibiting minimum and maximum transmission are generated increases. Therefore, the graph in Figure 15 shows the tendency, that for higher scan rates, the repeatability increases for short averaging times.

In contrast, the longer the averaging time is, the more polarization states are generated during the averaging time. The long averaging implies that a transmission minimum and maximum are averaged out, thus leading to wrong PDL values. Because of the random nature of the polarization scrambling method, the absolute minimum and maximum transmission values always become averaged with different transmission values during the averaging period. Thus, the final difference between measured minimum and maximum changes from measurement to measurement, leading to a worse repeatability. Also, the measured level of PDL might be lower, leading to increased uncertainty, as evident from Figure 16.

Figure 17 shows the measurement results using different sources. Again, the external Fabry-Perot Laser shows best performance. The PDL repeatability was determined to be smaller than  $0.0005\text{dB}$ .

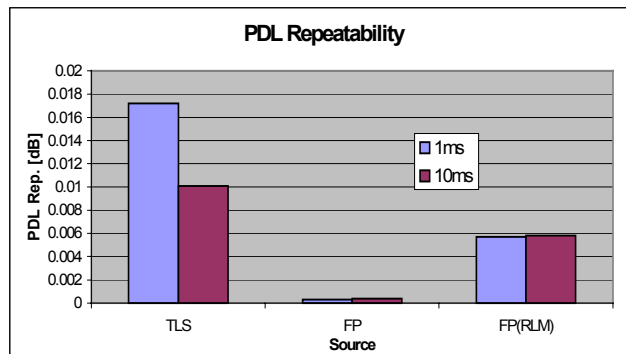

**Figure 17: PDL repeatability for different sources.**

## Reduction of PDL uncertainty with a depolarizer

One source of uncertainty for PDL measurements is the polarization dependent responsivity of the detector. This is mainly due to the fact that the light incident on the detector is still highly polarized<sup>8</sup>. If the polarization of the incident light changes, the responsivity of the detector can change, which is interpreted as a polarization dependent transmission change of the DUT.

Ideally, the light incident on the source should be completely depolarized. However, depolarization can only be effective if the coherence length of the source is sufficiently small. The coherence length of a source is related to its spectral linewidth, and in the case of the compact tunable laser source the linewidth is very narrow.

A simple way to reduce the degree of polarization is by using a polarization-maintaining fiber (PMF). Typically, depolarizers consist of consecutive parts of PMF. Each of the PM fibers has a different orientation of its axis compared to the other.

For simplicity, a single PMF patchcord has been used in order to demonstrate the depolarization effect. The measured DOP of the light exiting the PMF is shown in Figure 18.

Of course, care must be taken on where to place the PMF in the setup. If the PM fiber is placed before the DUT, the effect of depolarization is actually counteracting the purpose of the PDL measurement: exposing the DUT to different, but unique states of polarization. If depolarized light is incident on the DUT, its polarization dependence can not be fully determined, because the unpolarized part of the source would be unaffected by the DUT's PDL. Therefore, the change in measured power at the detector would be much smaller, leading to false PDL readings.

It is mandatory to place a PMF directly in front of the detector in order to avoid negative effects.

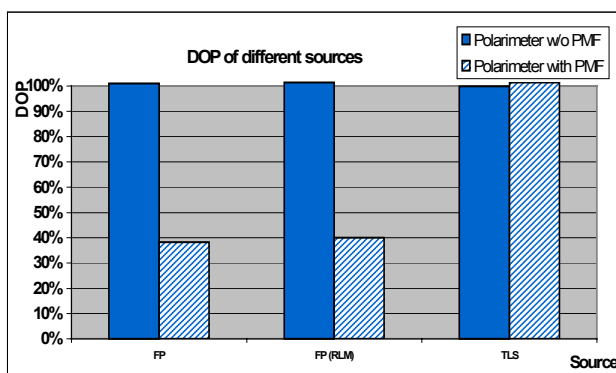

Figure 18: Depolarization of different sources using a polarization maintaining fiber.

From the measurement results it is obvious that narrow-linewidth sources, such as a compact tunable laser, stay unaffected. Their

<sup>8</sup> This assumes that the measured DUT does not exhibit depolarization effects on the light signal.

DOP is not reduced. However, the DOP could be reduced significantly for the Fabry-Perot sources.

This is also reflected in a comparison of the PDL uncertainty with and without the use of a PMF to the detector, as shown in Figure 19.

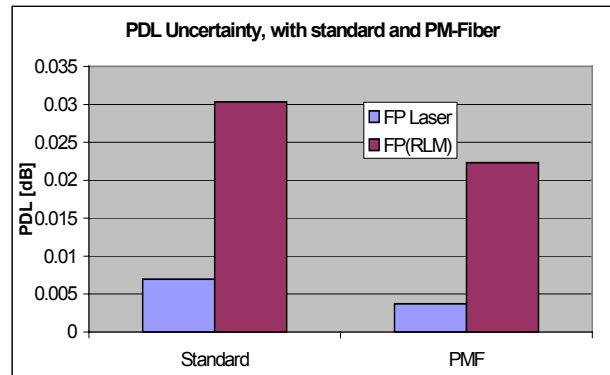

Figure 19: Comparison of the PDL uncertainty with and without using a polarization maintaining fiber (PMF) before the detector.

## Example Measurements

As an example, the PDL measurements of two devices<sup>9</sup> with different PDL are discussed. All measurements have been taken with an averaging time of 1ms and a scan rate of 6.

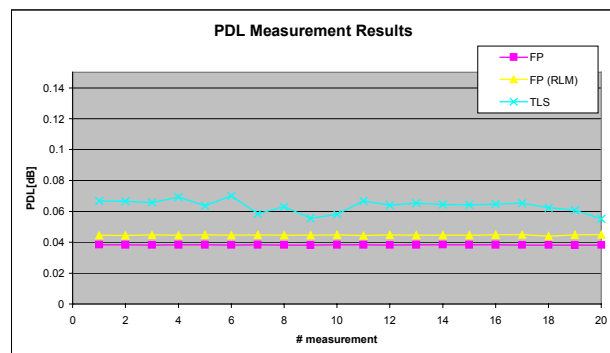

Figure 20: PDL measurement using different sources on a DUT with nominal PDL of  $0.05\text{dB} \pm 0.02\text{dB}$ .

The DUTs are PDL emulators with a nominal PDL of  $0.05\text{dB} \pm 0.02\text{dB}$ , and  $0.45\text{dB} \pm 0.02\text{dB}$ .

The measurement results show that the highest repeatability of measurements can be achieved with an external Fabry-Perot laser, as shown in Figure 21 and in Figure 23 for the DUT with nominal  $0.05\text{dB}$  PDL and  $0.45\text{dB}$ , respectively.

<sup>9</sup> Taliescent PDL emulators, with nominal PDL  $0.05\text{dB} \pm 0.02\text{dB}$ , and  $0.45\text{dB} \pm 0.02\text{dB}$ .

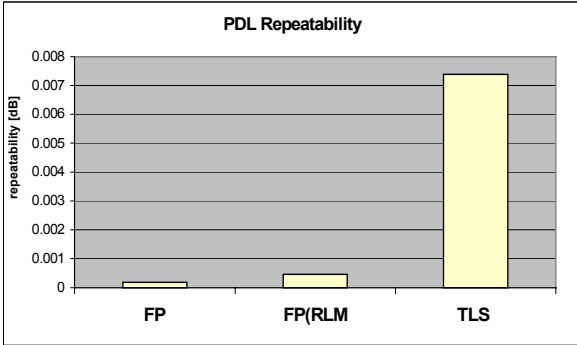

Figure 21: Repeatability of PDL measurements on a DUT with nominal PDL of  $0.05\text{dB} \pm 0.02\text{dB}$ .

The measured absolute PDL values do not correlate for the different sources, as can be seen in Figure 20 and Figure 22. This could be due to the fact that all used sources emit different wavelengths. However, all values are within the tolerance margins specified for DUT, which is  $\pm 0.02\text{dB}$ .

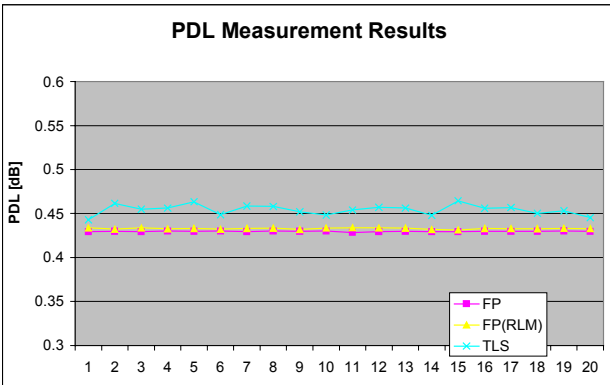

Figure 22: PDL measurement results with different sources on a DUT with nominal PDL of  $0.45\text{dB} \pm 0.02\text{dB}$ .

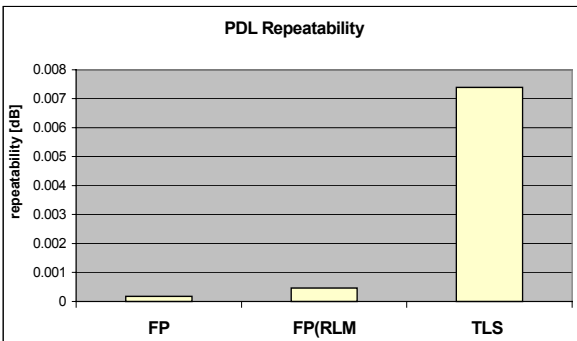

Figure 23: Repeatability of PDL measurements on a DUT with nominal PDL of  $0.45\text{dB} \pm 0.02\text{dB}$ .

## Return Loss

The Return Loss is the third loss parameter. The accuracy of Return Loss measurements is basically influenced by the reflections in the setup, and the quality of calibration.

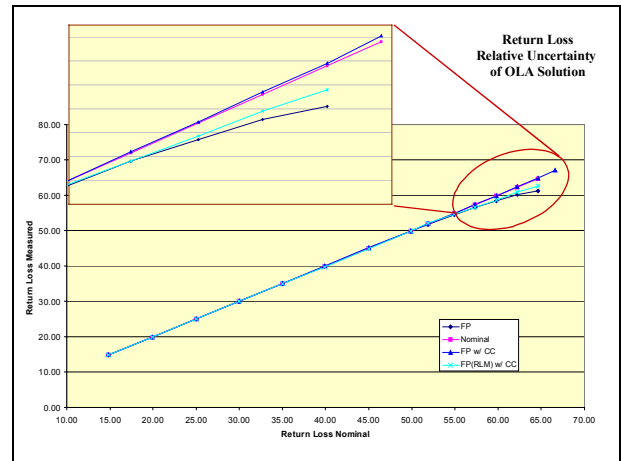

Figure 24: Return Loss Relative Uncertainty Measurement. The deviation from the nominal Return Loss gives an estimate for the uncertainty.

Straight to straight connector interfaces, especially, exhibit a return loss of 40dB, and are therefore inappropriate for high return loss measurements. Angled to angled connector interfaces have naturally a higher return loss, in the order of 55dB and above. Therefore, all instruments in the setup are required to have angled connectors, also and especially the polarization controller. This seems to be in contradiction to the general understanding that angled connectors exhibit PDL, which is true for open connectors. However, for angled connectors brought into physical contact with each other, the influence on PDL is negligible, and relatively much smaller than the impact of straight to straight connectors on return loss measurements.

Return loss measurements rely on excellent connector quality and cleanliness.

For a performance estimation, the return loss of a straight connector with known reflectivity has been compared to nominal return loss values. The straight connector was connected, as the DUT, to the polarization controller in the setups shown in Figure 4 and Figure 5. The dynamic range was scanned by introducing an optical attenuator<sup>10</sup>, with variable attenuation, between polarization controller and straight connector. All instruments were equipped with angled connector interfaces. By increasing the attenuation, the return loss value increases accordingly. The deviation from the nominal (calculated) return loss gives an estimate of the return loss accuracy.

<sup>10</sup> Agilent 8156A with angled connectors

Figure 24 shows the measurement results. The inset shows a zoom of the measurements for high return loss values. As can be seen, the measurement accuracy is extremely high when using the external Fabry-Perot laser in coherence control mode.

It can be even increased if the coherence control (CC) of the lasers is turned on. The coherence control modulates the laser intensity, which leads to a broadening of the laser linewidth. In consequence, interference effects are minimized, which can impair the measurement accuracy especially for high return loss values.

Figure 25 shows the deviation of the measured return loss from the nominal values.

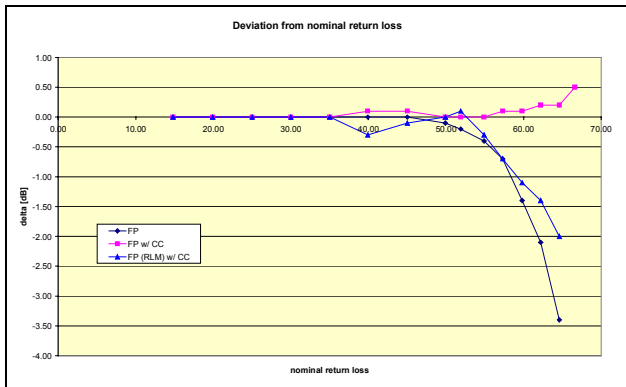

Figure 25: Deviation of measured Return Loss values from nominal Return Loss.

## Summary

The performance investigations clearly show, that the choice of the source is decisive for the achievable measurement accuracy, especially in PDL measurements. However, each source has its unique contributions to the optical all-loss analyzer solution. The external Fabry-Perot laser is recommended, when highest measurement accuracy and repeatability is desired. The Fabry-Perot Laser integrated into a Return Loss module cannot achieve the measurement performance as the external laser, but is recommended if measurement accuracy can be sacrificed in order to have an economic solution with small footprint. A tunable laser allows you to perform all measurements over wavelength.

To achieve highest measurement accuracy for all three loss parameters, careful design of the solution is important.

**Agilent Technologies'**  
**Test and Measurement**  
**Support, Services, and Assistance**

Agilent Technologies aims to maximize the value you receive, while minimizing your risk and problems. We strive to ensure that you get the test and measurement capabilities you paid for and obtain the support you need. Our extensive support resources and services can help you choose the right Agilent products for your applications and apply them successfully. Every instrument and system we sell has a global warranty. Support is available for at least five years beyond the production life of the product. Two concepts underlie Agilent's overall support policy: "Our Promise" and "Your Advantage."

**Our Promise**

Our Promise means your Agilent test and measurement equipment will meet its advertised performance and functionality. When you are choosing new equipment, we will help you with product information, including realistic performance specifications and practical recommendations from experienced test engineers. When you use Agilent equipment, we can verify that it works properly, help with product operation, and provide basic measurement assistance for the use of specified capabilities, at no extra cost upon request. Many self-help tools are available.

**Your Advantage**

Your Advantage means that Agilent offers a wide range of additional expert test and measurement services, which you can purchase according to your unique technical and business needs. Solve problems efficiently and gain a competitive edge by contracting with us for calibration, extra-cost upgrades, out-of-warranty repairs, and on-site education and training, as well as design, system integration, project management, and other professional engineering services. Experienced Agilent engineers and technicians worldwide can help you maximize your productivity, optimize the return on investment of your Agilent instruments and systems, and obtain dependable measurement accuracy for the life of those products.

**By internet, phone, or fax, get assistance with all your test & measurement needs**

**Online assistance:**

[www.agilent.com/comms/lightwave](http://www.agilent.com/comms/lightwave)

**Phone or Fax**

United States:

(tel) 1 800 452 4844

Canada:

(tel) 1 877 894 4414

(fax) (905) 206 4120

Europe:

(tel) (31 20) 547 2323

(fax) (31 20) 547 2390

Japan:

(tel) (81) 426 56 7832

(fax) (81) 426 56 7840

Latin America:

(tel) (305) 269 7500

(fax) (305) 269 7599

Australia:

(fax) (61 3) 9210 5947

New Zealand:

(tel) 0 800 738 378

(fax) 64 4 495 8950

Asia Pacific:

(tel) (852) 3197 7777

(fax) (852) 2506 9284

Product specifications and descriptions in this document subject to change without notice.

Copyright © 2002 Agilent Technologies

January, 17 2002

**5988-4975EN**



**Agilent Technologies**